

100D-9								
Mast Type		Maximum Fork Height	Overall Height (Lowered)	Free Lift Height	Mast Tilt		Load capacity 600mm LC	Truck Weight (Unloaded)
					Fwd	Bwd		
		mm	mm	mm	deg	deg	kg	kg
2 Stage Limited Free Lift	V300	3,025	2,850	150	15	10	10,000	12,781
	V350	3,525	3,100	150	15	10	10,000	12,842
	V400	4,025	3,400	150	15	10	10,000	12,915
	V450	4,525	3,650	150	15	10	10,000	13,092
	V500	5,025	3,900	150	15	10	10,000	13,153
	V550	5,525	4,200	150	15	10	9,000	13,227
3 Stage Full Free Lift	V600	6,025	4,450	150	15	10	8,000	13,373
	TS450	4,535	2,995	1,665	15	10	9,700	13,655
	TS500	5,035	3,195	1,865	15	10	9,400	13,785
	TS550	5,535	3,395	2,065	15	10	8,600	13,898
	TS600	6,035	3,595	2,265	15	10	7,800	14,107
	TS750	7,535	4,195	2,865	15	6	7,000	14,427

100D-9

Internal Combustion Diesel Engine Forklift Truck

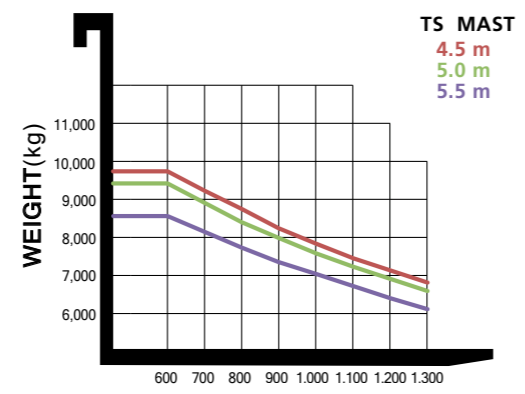
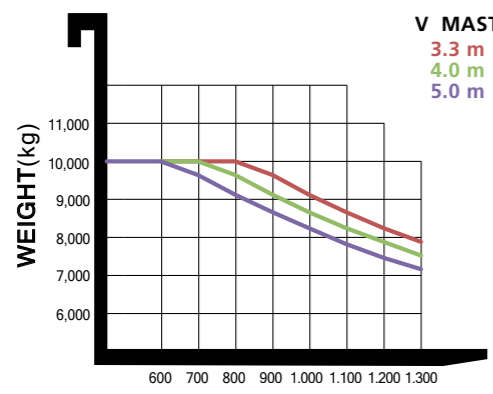

100D-9 - Start of a change in the 10-ton forklift market!

100D-9 is an innovative product that can reshape the market with its optimum fuel efficiency that satisfies Tier 3 Regulations, powerful performance, differentiated convenience, and convenient maintenance.

**PRODUCT FEATURES
OVERVIEW**

**UP
VALUE**

As times change, the standard for high performance should also change

■ High torque and work efficiency in mid-/low-speed sections

3.2% ↑

Higher fuel efficiency than 80D-9

*ECO-FRIENDLY
ECONOMICAL*



Environment-Friendly

- Tier 3 regulations on gas and achieves both eco-friendliness and operating expenses reduction with improved fuel efficiency.
 - Cummins F3.8 engines

Innovative cost-effectiveness and reliable durability

- Significant TCO reduction - 3.2% higher fuel efficiency than 80D-9(Tier 4 Final)
 - High torque property in mid-/low-speed sections
- HG F80 T/M controlled by MCU
 - Control of response, transmission time, and inching property
 - Auto & Manual shifting mode
- Selection of engine working mode according to working conditions
 - "PWR/STD mode" "idle RPM up/down"

Differentiated safety specifications

- Auto-parking brake
 - Automatically started when the engine is stopped or OPSS is running
- OPSS - Restricted driving, lift and tilt operation
- Seat belt interlock **Option**
 - The forklift cannot be operated when the seat belt is not worn
- Road slope warning
 - Alarm warning when the road slope exceeds the standard
- Password-start limit
 - Prevents theft by prohibiting forklift operation by an unauthorized operator

Prominent driving comfort specifications

- Remote control-type hydraulic control valve
 - Light and precise control by 0.5kg lever operation
 - Designed for high accessibility to the no.4 and no.5 levers by arranging levels in 5 degrees
- Deluxe cabin with improved convenience and pleasant work environment **Option**
 - Wide and clean surrounding work view
 - A/C and heater included
 - Achievement of low indoor noise level (73.3dB)
- Air suspension / swivel seat **Option**

Easy and convenient follow-up management

- Auto-tilting cabin that opens up to 52 degrees
 - Innovative reduction of maintenance time
 - Restricting cabin tilting when opening the passenger door to prevent cabin damage accidents
- Easily accessible Fuse & Relay Box
- Main control valve with emergency lowering function

100D-9

Eco-friendly Cummins F series engine

Cummins QSF Series Engine is globally mounted in heavy equipment and complies with Tier 3 Regulations. Its powerful torque property in mid/low-speed sections shows excellent fuel efficiency in rapid and efficient complex work and heavy-duty traction work.



	100D-9
Model/cc	QSF3.8/3,726cc
Rated Power(kw/rpm)	94.8/2,200
Max. torque(kg-m/rpm)	51/1,500

Innovative reduction of operating expenses

With displacement optimized for forklifts and high torque in mid/low-speed sections, 100D-9V offers higher fuel efficiency than 80D-9.

* Urea consumption increases as the EGR has been removed.

3.2% ↑

Higher fuel efficiency than 80D-9(Tier 4 Final)

• Fuel economy is based on our internal tests (VDI 2198) and may be different from actual operation.



ENVIROMENT FRIENDLY
GREAT PRODUCTIVITY, DURABILITY

UP
PERFORMANCE

An eco-friendly engine ensures both cost-effectiveness and work efficiency!

Check out the flawless performance of 100D-9 only.

HG Transmission (F80)

F80 T/M of HG consisting of F2/R1 and 2 stator-type torque converter is controlled by MCU, with the inner parts protected from impacts during travel and direction change (DCSR).



Engine output selection button

- ① PWR/STD button - STD mode is set to 80% output of PWR mode and can be selected according to the work conditions.
- ② Idle RPM Up/Down button - When slowly lifting cargo without stepping on the accelerator pedal, the engine output can be supplemented. (Adjustable by increments of 25 RPM)



Kessler Drive axle (D41)

The D41 drive axle of a German heavy equipment company Kessler is mounted. This drive axle contains semi-permanent wet disc brake and SAHR caliper-type auto-parking brake.

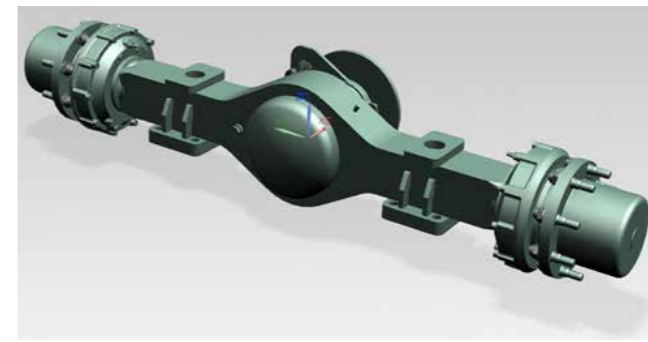

Wide work sight of the TS mast **Option**

Generally, the 3-stage mast causes inconvenience in securing a clear front view due to the primary cylinder in the center. The 3-stage TS mast provides wider work sight by placing the primary cylinder on the left and right sides.



100D-9

Password Setting

A password can be set to prevent unauthorized driving by an outsider and theft of the forklift. If the password is set, the engine cannot be started without the password.

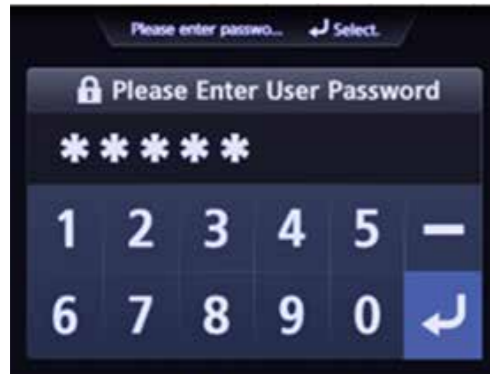

Auto-parking brake

When the engine stops or OPSS starts, the parking brake is automatically activated to prevent human errors. If the driver needs to use the parking brake while the engine is running, driver can apply/release the brake using a dedicated button.

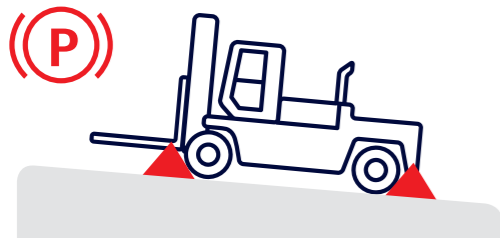

OPSS system

The OPSS restricts driving, lifting, and tilting when the operator leaves the driver's seat in order to prevent accidents.

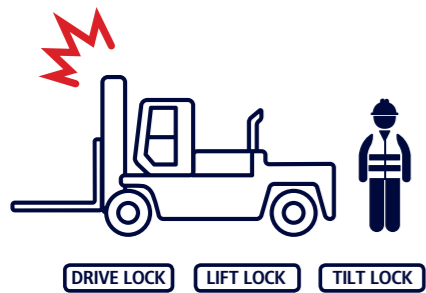

Additional options for safety

- Auto-tilting – Automatically maintaining the level of the fork and the ground
- Seatbelt interlock – Forcing the wearing of seat belt to prevent secondary accidents



ENHANCED SAFETY

UP SAFETY

Safety at the logistics site is most important. The safe and differentiated design ensures safety of the logistics site.

Speed limit

The maximum driving speed can be set to prevent accidents caused by exceeding the speed limit. Even though the maximum driving speed is set, hill-climbing ability and mast working performance are maintained at the highest level.



Large side mirror with hot wires Option

A large side mirror is installed on the front wheel fender to secure a wider rear view. In addition, heat wires were inserted into the side mirror to cope with rain or snow.

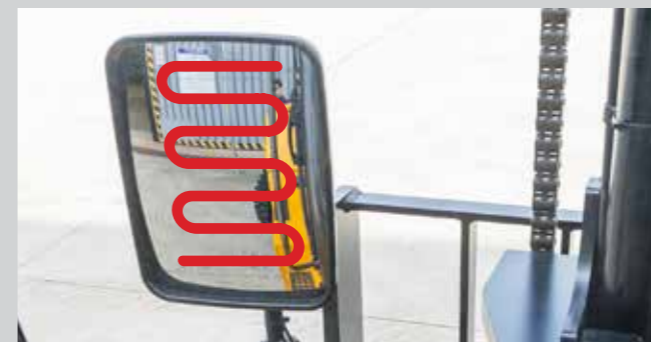

Displaying the road slope (STD) and overload alarm Option

The road slope is sensed and displayed in real time. When the set value is exceeded, the symbol turns red, and a warning buzzer goes off. In addition, the optional cargo weighing device issues an alarm for safety in case of overload.



100D-9

Maximized operation convenience – Differentiated cabin **Option**

Higher levels of convenience and work efficiency are provided with the configuration of remotely controlled hydraulic lever, electrical inching system, and full suspension seat.

Auto shifting system

A transmission control program is installed on the digital cluster for automatic gear shifting of the first and second gears depending on the rotation rate of transmission-out shaft to prevent the reduction of service life of transmission caused by forced start at forward second gear. (Switching to manual mode allowed)



Air suspension / swivel seat **Option**

"Air suspension" that provides optimal riding comfort and the "swivel seat" which will improve reverse driving and convenience of getting on/off as the seat can be rotated 20 degrees to the right and 10 degrees to the left are provided as an option.

* Basic specification: Full-suspension Grammer seat

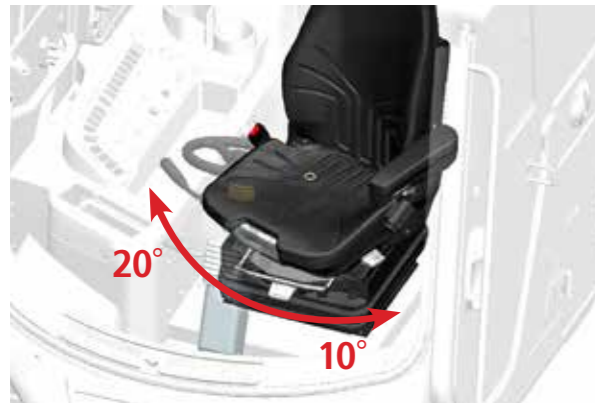

Multi-functional digital display

A new cluster is applied for improved visibility of the main information needed for equipment operation. The cluster has integrated MCU for various settings and control for efficient operation and safety of the equipment on the LCD.



OUTSTANDING OPERABILITY
ERGONOMICS

UP
CONVENIENCE

Increasing work efficiency
to the next level with
consistent convenience in
any condition

Easy-to-use steering handle

The problem of heavy handle when handling abruptly is improved, as now the handle can be adjusted up and down by 85mm and front and back by 36 degrees. In addition, the work convenience of the driver is improved with the handle diameter being reduced down to 35mm.



Improved emotional quality of operation – RCV

It boasts of soft operability, wide precise control section, and independent load sensing function, with the no.4 and no.5 levers arranged in 5 degrees from horizontal plane focused on RCV for convenient operation providing a guaranteed satisfaction.



Inching and brake pedal that are easy to operate and efficiently placed air vent

Fatigue accumulated in the legs is reduced by changing the brake pedal and inching pedal to a hanging type. The air conditioning effect is improved by installing two air vents above the pedal.



Front sight

- Applied single curved glass, removing distortion of vision in corners
- Double-arm large wiper—Removing water from a wider area
- 7-inch monitor for the rear camera only



Rear sight and air vents

- Applied flat glass without distortion of view
- Applied single-arm wiper as a standard
- Air vent (left and right symmetrical) that controls the air volume in four directions



Upper window / sun visor

- Applied single-arm wiper as a standard
- Ceiling interior materials with high insulation effect
- A sun visor that can control the position in three phases and which is made of materials that reflect the direct rays of the sun



Protecting the glass and field of view on the left / right

- Minimizing blind spots in the field of view
 - Whole glass structure that has no filler in the middle of the door / Increased glass area
- Preventing direct collision with glass when moving objects in the cabin

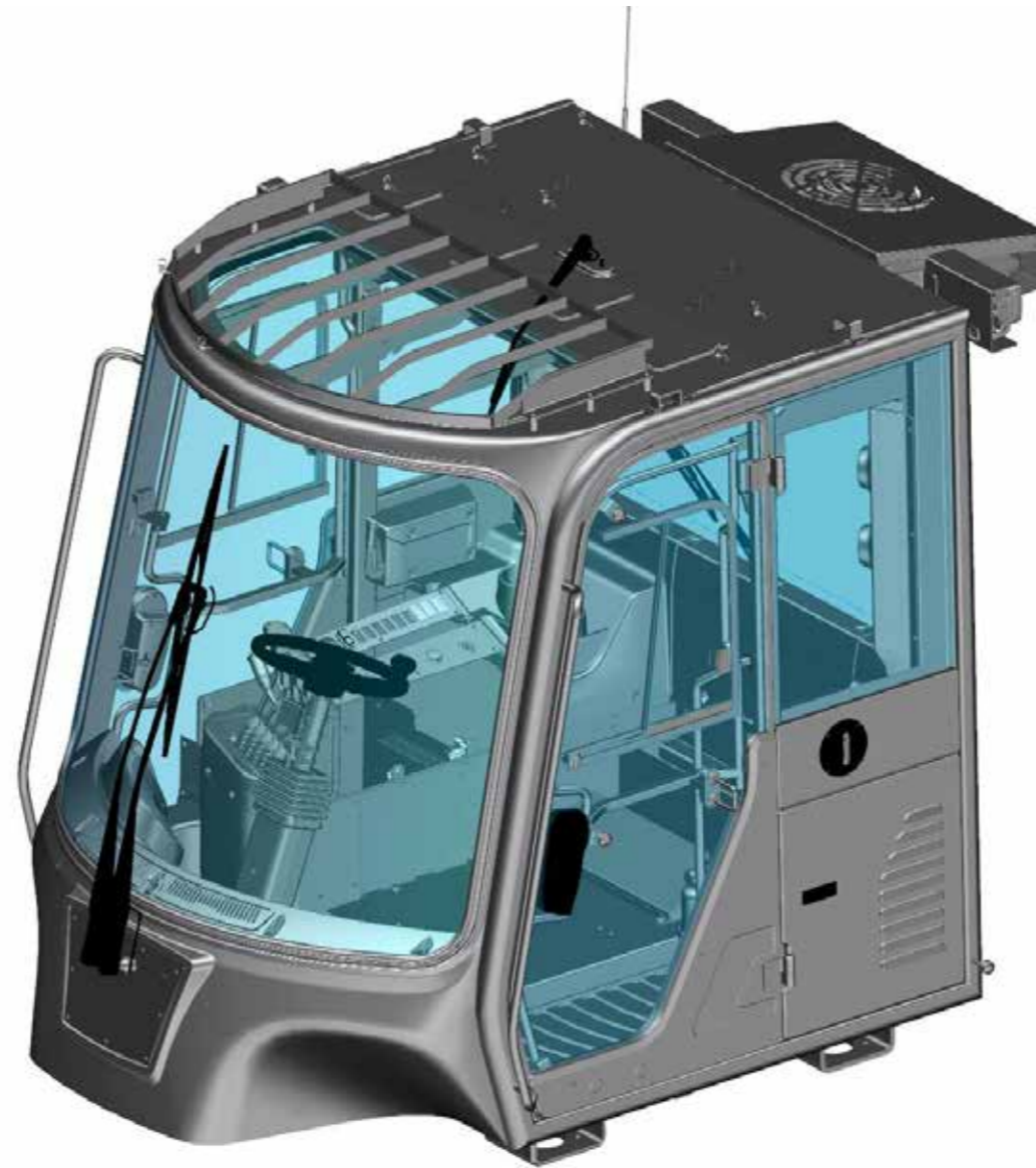

Optimal air conditioning – multiple air vents

- Upper side of the cabin : 2 left and right C pillars each (4 in all)
- Dashboard : 2ea on the top of the pedal
- Removing windshield moisture : 2 ea on the front of the dashboard



Console – improved accessibility

- Placed switches in one row (in order of use frequency)
- Applied the 12V power port (2ea)
- Placed the air conditioning control dial near the headliner



2 storage spaces separated by use

- ① Mobile device
- ② Beverage bottle / can

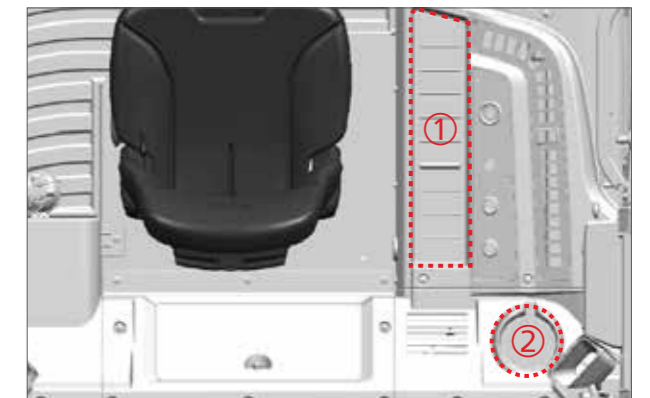

100D-9V

Significant reduction in maintenance time – Tilting cabin

The cabin is tilted up to 52 degrees to provide larger work space for a significant reduction of maintenance time. The cabin may be tilted manually or automatically.

Self-diagnosis of engine and consumables management

The failure details and history can be checked on the cluster screen. In addition, when the replacement cycle of any consumables is entered into the cluster, parts in need of replacement are displayed on the monitor.



2019. 01.01 SUN 06:20

Item	Interval	Elapse	Count	Alarm
Axle Gear Oil	100	105	0	●
Transmissing Oil	100	105	0	●
Filter	100	105	0	●
Tank Air Breathe...	250	105	0	●
Engine Oil	500	105	0	●
Element	500	105	0	●

No tilting when the door is opened & cabin tilting switch

If the right door is open, damage to the door is prevented by prohibiting cabin tilting. The cabin can be opened and closed both automatically or manually.

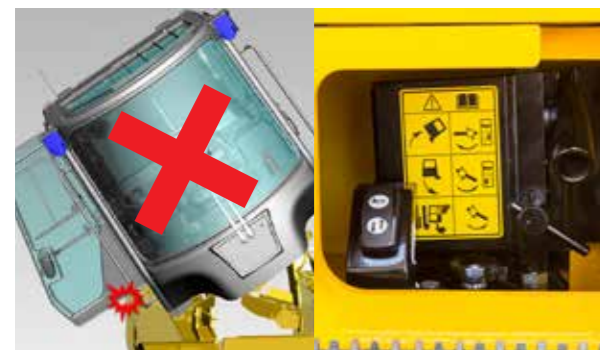

Fuse and Relay box

Fuses and relays, which are most frequently checked and replaced among electrical apparatuses, are arranged in a separate airtight space outside of the cabin to guarantee system credibility and save post-management time.



Maintainability of hydraulic control valve

The load-sensing hydraulic control valve is designed to have minimum leak in the spool, and its lowering speed control function and the emergency mast lowering screw, and etc. reduce service frequency and idling time for maintenance.



EASY SERVICE

UP MAINTENANCE

Easy maintenance and cost-effective after-sales service
Even though the work is finished, the satisfaction continues



Hi-MATE Option

Forklift operation and status, safety, and human resources can be remotely managed using the on-site management solution Hi-MATE. The accumulated data can be used for devising a forklift operation plan.



Hi-MATE, a solution for field control based on data

Data collected at the sensors and modules mounted on equipment during the operation of forklift truck at the operation control system of Hyundai Industrial Vehicle is provided to the mobile device or computer of the customer in real time through the server of Hyundai Construction Equipment. Such visual data can be used for establishing a control plan for safety control in fields, productivity improvement, and cost saving.



Equipment operation management

- * Real-time monitoring and follow-up management of individual vehicles, drivers, equipment on-site, and operation information
- Key-on time, travel hours, work hours, and traveling position



Equipment status management

- * Supplying information of the forklift truck linked with operation hours, establishing a follow-up management plan
- Indicating fuel remainder, failure information
- Indicating consumable exchange timing, service timing



Safe traveling control

- * Checking and follow-up management of safety accident caused by collision between the field system and forklift truck during operation
- Count of collision, size of impact



Human resource management

- * Checking and follow-up management such as matching between self-diagnosis and equipment conditions before operation
- Driver authorization, self-diagnosis of equipment conditions

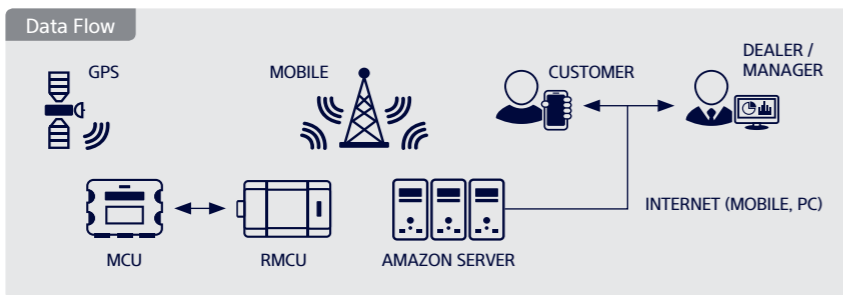

Standard & Option

		Description	100D-9			Description	100D-9			
OPERATION ROOM	Cabin	New Cabin(Aircon, heater)	○	HYDRAULIC	MCV & Hoses	3 Spool MCV + attached piping for V300 Mast	●			
	Seat	Grammer seat + Orange belt + Arm rest	●		TIRE	Tires	MCV Options - 4 Spool, 5 Spool	○		
		Air suspension seat / swivel seat	○				Pneumatic Tires	●		
		Seat Accessories - Buckle switch, Seat switch, Backrest, Heated seat	○				Solid Tires	○		
	Lever	Manual Lever	●		VISIBILITY	Mirror	Lamp	Working Lamp - Front & Rear LED	●	
		Radio & USB	○				L/H & R/H Back Mirror & Panorama Mirror	●		
		etc.	Bluetooth Radio				○	Heated L/H & R/H Back Mirror & Panorama Mirror	○	
	MAST & ATTACHMENT	Mast	Standard Mast		V300	CONVENIENCE	-	Camera	Rear Camera	●
			2 stage Mast		○			Around view	○	
			3 stage Mast		○			Load Sensor	○	
Fork		Standard Fork	1,200mm	SAFETY	-	Accumulator	○			
		Fork Options - 1,350mm~2,400mm Fork	○			OPSS - Travel & Mast	●			
Carriage		Shaft Type Carriage	●	OTHERS	-	OPSS - Travel only	○			
		Carriage Options - Shaft type, Intergral Shaft type	○			Seat Belt interlock	○			
			○			Master Switch	○			
Attachment		Fork Positioner - Independent, Synchronized	○	LED Beacon Lamp	○					
		Intergral Side Shift	○	Oil - VG46	●					
	Side Shift & Positioner - Independent, Synchronized	○	Oil Options - VG32 for Tropical, VG15 for Cold Area	○						
						Hi-MATE (General)	○			
						Hi-MATE (Premium)	○			

● STD / ○ OPT

Specification

Identification			
	Manufacturer (abbreviation)		Hyundai
	Manufacturer's type designation		100D-9
1.1	Drive : electric (battery or mains), diesel, petrol, fuel gas		DIESEL
1.2	Type of operation: hand, pedestrian, standing, seated, order-picker		Seated
1.3	Load capacity / rated load	kg	10,000
1.4	Load center distance	mm	600
1.5	Load distance, center of drive axle to fork	mm	690
1.6	Wheelbase	mm	2,750

Weights			
2.1	Service Weight	Kg	12779
2.2	Axle Loading, Loaded Front/Rear	Kg	20,444 / 2,335
2.3	Axle Loading, Unloaded Front/Rear	kg	5,644 / 7,135

Wheels, Chassis			
3.1	Tires : solid rubber, superelastic, pneumatic, polyurethane		P
3.2	Tire size, front		9.00-20-14PR
3.3	Tire size, rear		9.00-20-14PR
3.5	Wheels, number front / rear (x = driven wheels)		4x2
3.6	Tread, front	mm	1,693
3.7	Tread, rear	mm	1,700

Basic Dimensions			
4.1	Tilt of mast/fork carriage forward/backward	degrees	15/10
4.2	Height, mast lowered	h1 (mm)	2,850
4.3	Free lift	h2 (mm)	150
4.4	Lift height	h3 (mm)	3,025
4.5	Height, mast extended	h4 (mm)	4,360
4.7	Height of overhead guard (cabin)	h5 (mm)	2,680
4.8	Seat height / stand height rel. To sip	h7 (mm)	1,650
4.12	Coupling height	h10 (mm)	602
4.19	Overall length	l1 (mm)	5,465
4.20	Length to face of forks	l2 (mm)	4,265
4.21	Overall width	b1 (mm)	2,265
4.22	Fork dimensions	l x e x s (mm)	75x180x1200
4.24	Fork-carriage width	b3 (mm)	2,265
4.31	Ground clearance, below mast, loaded	m1 (mm)	250
4.32	Ground clearance, center of wheelbase	m2 (mm)	306
4.34.1	Aisle width for pallets 1000 x 1200 crossways	Ast (mm)	5,590
4.34.2	Aisle width for pallets 800 x 1200 lengthways	Ast (mm)	5,790
4.35	Turning radius	Wa (mm)	3,965
4.36	Smallest pivot point distance	mm	1,354

Performance Data			
5.1	Travel speed, loaded / unloaded	km/h	28.4/33.4
5.2	Lift speed, loaded / unloaded	mm/s	400/450
5.3	Lowering speed, loaded / unloaded	mm/s	450/450
5.6	Max. Drawbar pull, loaded / unloaded	kg.f	87946/
5.8	Max. Gradeability, loaded / unloaded	%	33.8/
5.10	Service brake		Hydraulic

Combustion-Engine			
7.1	Engine manufacturer / type		QSF3.8
7.2	Engine power acc. To iso 1585	kW/rpm	93/2,200
7.3	Maximum torque	kgf.m/rpm	51/1,320
7.4	No. Of cylinders / displacement	eA/cc	4/3,726

Addition Data			
8.1	Type of drive control		Full auto
8.2	Operating pressure, system / attachments	bar	245/157
8.3	Oil volume for attachments	LPM	110
8.5	Trailer coupling, type din		Pin

