



MOVING YOU FURTHER

16·18  
**20B-9**



Some of the photos may include optional equipment



# Your satisfaction is our priority.

**Robust AC technology!**

## **Hyundai's 9-series small battery forklift**

Hyundai introduces a new line of 9-series battery forklifts.

The newly designed four-wheel counterbalance forklift maximizes productivity by enabling comfortable driving and easy maintenance.

### **Work efficiency & productivity**

- Strong and exquisite driving performance of a dual drive motor
- Optimized performance mode setting (H,N,E)
- Easy and efficient directional & horn switch on lever (OPT)
- Curve control
- Load weight indicator (OPT)

### **Durability & reliability**

- AC motor exclusive - IP65 ZAPI controller
- Semi-permanent wet disc brake
- IP43 AC motor

### **Safety**

- Anti-roll back system
- Turtle mode & Speed limit setting
- Operator Presence Sensing System (OPSS)
- Panoramic rear view mirror

### **Maintenance**

- Self Diagnostics function
- Password starting system
- Brake oil level sensing system





Power & Performance

# High Efficiency & Optimal Performance

An efficient, smooth running and compact design provides enhanced performance and outstanding productivity.



Some of the photos may include optional equipment.

## Strong driving power : Dual drive motor system

The dual drive motor system consists of two separately controlled drive motors. Unlike the single drive motor system, it prevents the wheels from spinning even when the grip force of the left and right wheels is different. In addition, it enables strong drive performance even on a dirty road. As the pivot point is the axle of the wheels, the dual system enables relatively small turning radius compared to the single system, thus improving efficiency in small worksites.

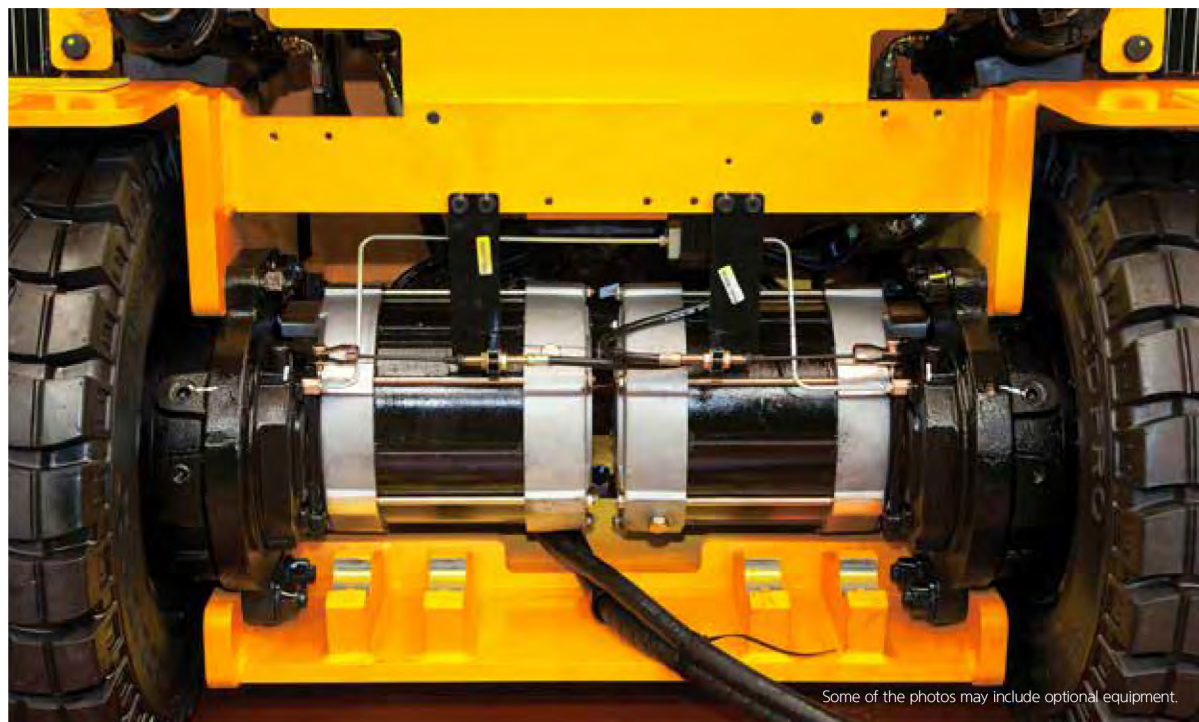

Some of the photos may include optional equipment.



### Robust and economical AC motor

Drive and pump motors using AC technology provide great controllability and durability, compared to DC motors. Also, AC motors without the commutator and brushes cost less to maintain. In addition, it has been tested and passed for IP43 protection rating.



### Wet disc brake

The semi-permanent wet disc brake provides constant braking force without overheating even when used for long hours of repetitive work, thus improving work efficiency. Without requiring brake linings, which needs regular replacement, maintenance costs are relatively low.



### New ZAPI controller

The almost noiseless 8 kHz (high frequency) ZAPI controller enables high efficiency control and protects the system from low and high voltages and overheating.



### Optimized operation mode setting

Through the cluster and the performance selection function of ZAPI controller, the operator can select an optimal performance mode depending on working conditions, worksite size and operator proficiency. H (High), N (Normal) to E (Economic)



### Curve control

Curve control limits travel speed based on turning radius for a smooth, precise turning operation for the driver.



### Prolonged battery use

When the operator's foot is lifted from the accelerator, the kinetic energy is converted to electrical energy and stored in batteries. The operator can stop the vehicle with the energy generated from the energy conversion.



### Directional & horn switch on lever (OPT)

Electronic directional control and secondary horn are mounted to the hydraulic lift lever for quick and precise maneuvering.



### Finger tip control levers (OPT)

The electric control lever reduces operator fatigue, and the ergonomically designed armrests can be adjusted up, down, forward and backward for operator's body types.





Easy & Comfort

# Optimized Ergonomics & Fast and Easy Maintenance

An ergonomically designed workspace for operator provides the best comfort and easy access for maintenance.



Some of the photos may include optional equipment



## Ergonomically designed workspace

Ergonomic design focusing on operator convenience and maneuverability further enhances work efficiency. Easy to operate levers and pedals, adjustable handle, suspension seat and a large multi-functional cluster dashboard allow comfortable and efficient driving. A 12V power socket is a standard feature to improve operator convenience.

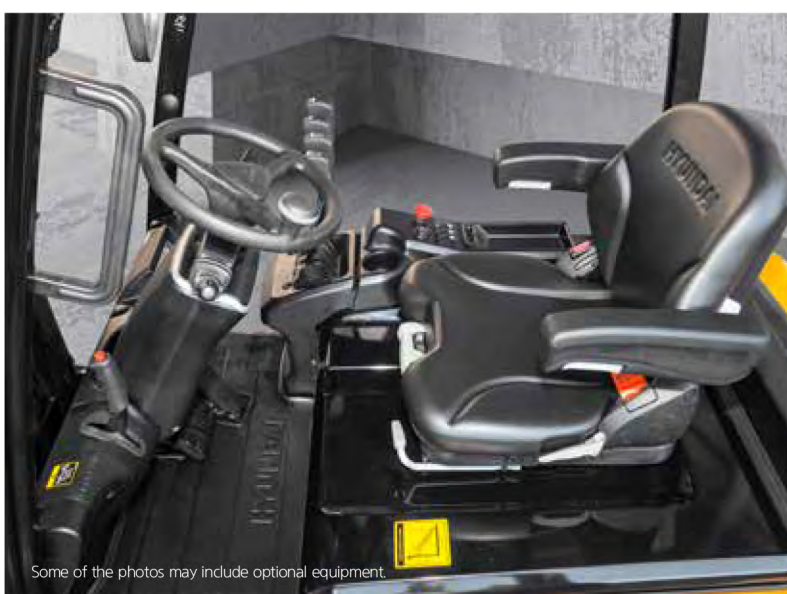

Some of the photos may include optional equipment



### Grammer seat

An adjustable ergonomic seat provides unmatched comfort. The adjustable armrest further reduces operator fatigue.

- ELR(Emergency Locking Retractable) type seat belt
- Seat heater (STD) & headrest (OPT)

## 3.5 inch LCD color monitor

The 3.5 inch TFT LCD color monitor indicates speed, steering angle & driving direction, battery charge level and hour meter & working mode, thus allowing easy and efficient control for the operator. In addition, diagnostic error codes allow easy fault diagnosis.



### Main functions of the monitor

- Steering wheel position & driving direction
- Turtle mode
- Driving speed (Digital)
- Battery discharge indicator
- High temp warning lamp
- Wrench warning light
- Roll up
- ESC
- Menu / Scroll left
- Performance / Scroll right
- Enter
- Turtle / Scroll down

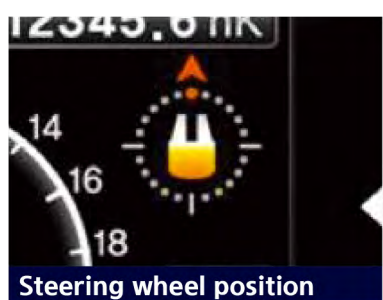

### Steering wheel position

A steering sensor is applied to the king pin of the rear axle, communicates to the LCD color monitor to show the direction of the vehicle as it relates to the angle of the steer wheel.



### Open footplate

Non-slip and wider open steps offer convenience and safety when entering and exiting vehicle.



### Adjustable tilting handle

The handle angle can be adjusted with the lever on the right side of the steering wheel to suit the operator's physique and driving habit.



### Easy maintenance of battery

The battery cover opens fully with the assistance of a gas strut that locks when fully opened to give easy access to battery and prevent the hood from dropping.



### Brake oil reservoir with level sensor

The enhanced brake oil reservoir, located in the upper left dash is equipped with an electronic level sensor that shows the level in the LCD color monitor.



Secure & Safety

# Advanced Safety

The safely designed driver's space makes your operating more comfortable.

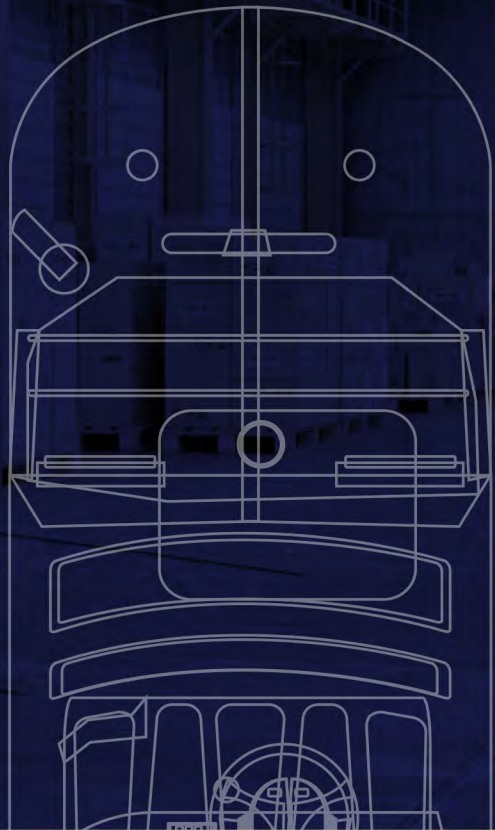

Some of the photos may include optional equipment.

## Great visibility for safe operation

The optimized lift cylinder array design provides a clear, wide field of vision for the operator. A rear camera(OPT) and panoramic mirror expands the driver's view when backing up.

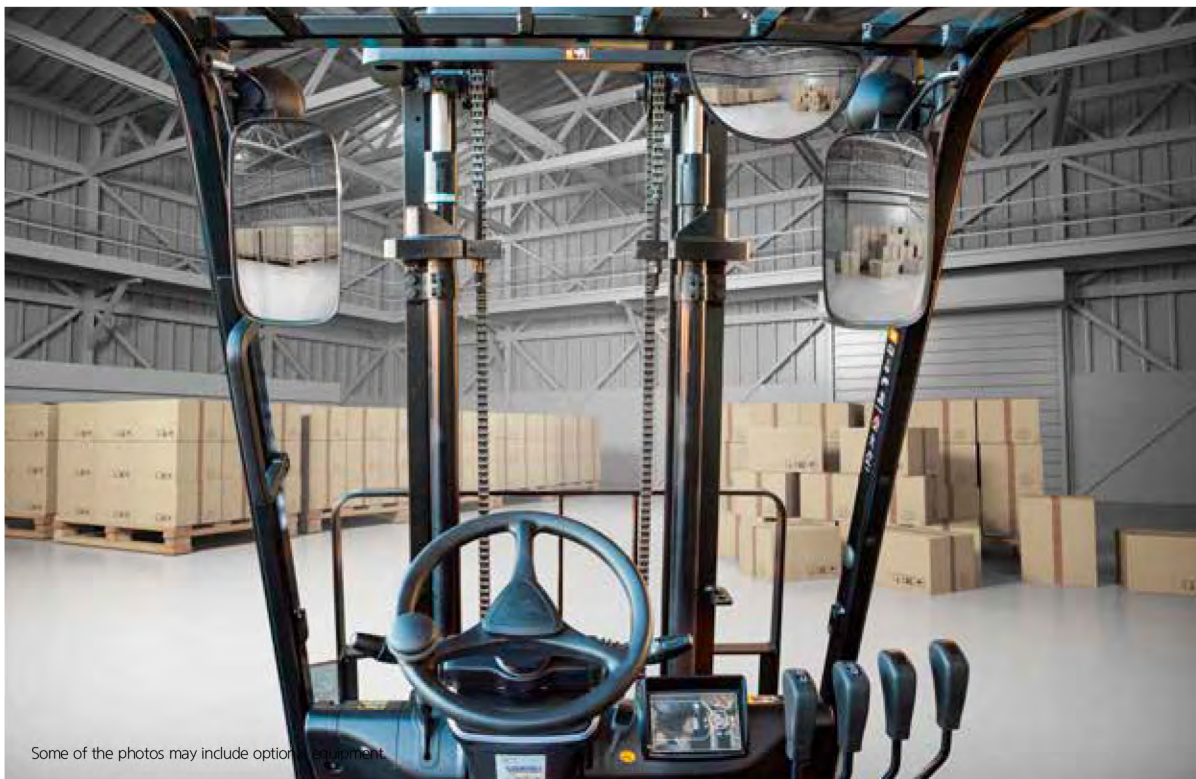

Some of the photos may include optional equipment.



**Strong overhead guard**

Exceeding ISO6055 regulations, the overhead guard offers great protection combined with excellent all around visibility.



**Panoramic mirror**

The panoramic mirror expands the driver's view when backing up.

### Maximum speed control

The operator can set and limit the maximum speed from 10 km/h by 1 km/h unit, given the curve & congestion of an aisle and the shape of the load.

### Password starting system

The operator can set a password to prevent vehicle theft and possible safety accidents in case the vehicle is used by an unauthorized person.

## Safety system to prevent accidents in advance

The high-sensitive sensor prevents in advance possible accidents caused by the operator's mistake or unexpected events. The operator can thus focus on work without worrying over safety in an intensive work environment.

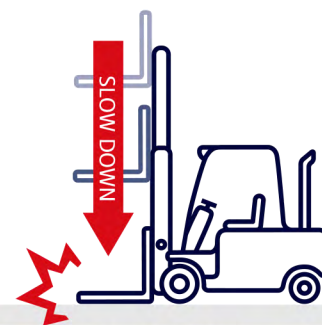

**Fork safety features**

As the forks are being lowered, a down-control valve maintains a controlled descent speed. The down-safety valve prevents forks from dropping down in case of sudden damage of hydraulic line.



**Strengthened work safety**

Rear LED lights and halogen lights offer excellent visibility even during night operations. Safety has been increased by installing an additional reflector on the counterweight.



**Anti-Roll Back system**

Anti roll-back system offers protection against the machine rolling back on a ramp in combination with exceptional ramp start capabilities.

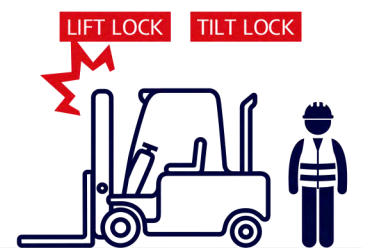

**Operator presence sensing system (OPSS)**

When operator is not in seat the hydraulic lift and tilt controls and travel are locked out.

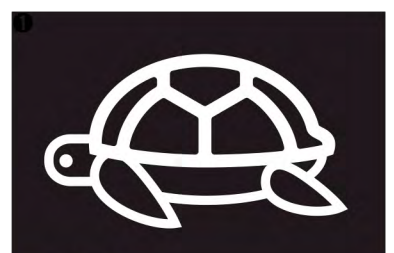

**Turtle Mode**

Selecting turtle mode allows the operator to reduce travel to a pre-set speed, which is ideal when working in narrow and or congested work areas.



# IPAS : Intelligent Proximity Alert System (OPT)

Emits a warning (vibration, warning noise) in each area by measuring the distance between the forklift and a nearby pedestrian in real time via wireless communication.

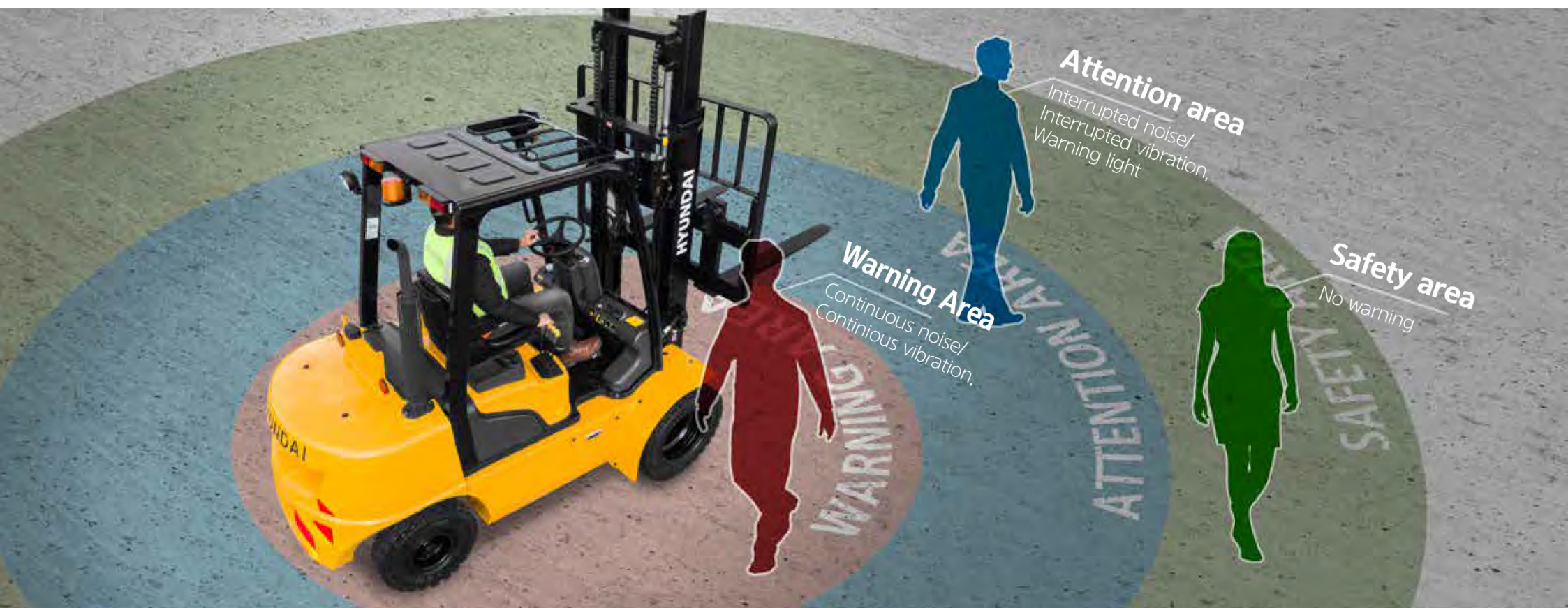
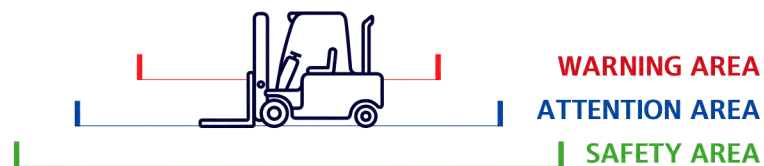

# Fleet Management System(Hi FLEET) (OPT)

Hi FLEET, Hyundai Material Handling's fleet management system, is the optimal operation solution for a fleet of forklifts. It connects driver and vehicle in real time.

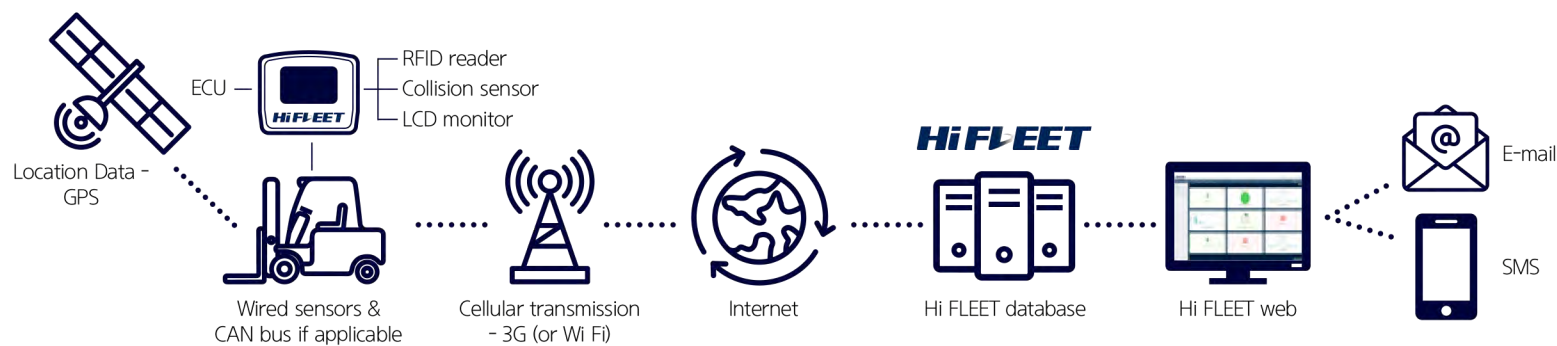

# New 9 Series Mast Specification

16/18/20B-9

## 16B-9

Mast Type	Maximum Fork Height		Overall Height (Lowered)		Free lift height						Tilt Angle		Load capacity w/o side shift		Load capacity w/side shift		Truck Weight (Unloaded)		
	in	mm	in	mm	With Load Backrest		Without Load Backrest		Without Load Backrest (3/4-SPOOL)		Fwd deg	Bwd deg	24 in LC lb	500mm LC kg	24 in LC lb	500mm LC kg	lb	kg	
					in	mm	in	mm	in	mm									
2-STAGE LIMITED FREE LIFT	V250	99.4	2,525	67.7	1,720						5	7	3,200	1,600	3,100	1,530	6,830	3,098	
	V270	107.3	2,725	71.7	1,820						5	7	3,200	1,600	3,100	1,530	6,856	3,110	
	V300	119.1	3,025	77.6	1,970						5	7	3,200	1,600	3,100	1,530	6,900	3,130	
	*V330	130.9	3,325	83.5	2,120						5	7	3,200	1,600	3,100	1,530	6,944	3,150	
	V350	138.8	3,525	87.4	2,220	1.4	35	1.4	35	1.4	35	5	7	3,200	1,600	3,100	1,530	6,973	3,163
	V370	146.7	3,725	91.3	2,320	1.4	35	1.4	35	1.4	35	5	7	3,200	1,600	3,100	1,530	7,002	3,176
	V400	158.5	4,025	97.2	2,470	1.4	35	1.4	35	1.4	35	5	7	3,150	1,550	3,040	1,490	7,057	3,201
	V450	178.1	4,525	111.0	2,820	1.4	35	1.4	35	1.4	35	5	5	3,040	1,500	2,950	1,440	7,205	3,268
	V500	197.8	5,025	120.9	3,070	1.4	35	1.4	35	1.4	35	5	5	2,810	1,400	2,750	1,340	7,280	3,302
2-STAGE FULL FREE LIFT	V550	217.5	5,525	130.7	3,320	1.4	35	1.4	35	1.4	35	5	5	2,750	1,350	2,660	1,300	7,324	3,322
	VF/V5300	119.1	3,025	77.6	1,970	38.3	972	58.2	1,479	52.7	1,339	5	5	3,200	1,600	3,100	1,530	6,986	3,169
2-STAGE FULL FREE LIFT	VF/V5330	130.9	3,325	83.5	2,120	44.2	1,122	64.1	1,629	58.6	1,489	5	5	3,200	1,600	3,100	1,530	7,033	3,190
	VF350	138.8	3,525	87.4	2,220	48.1	1,222	68.1	1,729	62.6	1,589	5	5	3,200	1,600	3,100	1,530	7,066	3,205
3-STAGE FULL FREE LIFT	TF370	147.0	3,735	69.7	1,770	30.4	772	47.4	1,205	41.9	1,065	5	5	3,150	1,550	3,040	1,490	7,156	3,246
	TF400	158.9	4,035	73.6	1,870	34.3	872	51.4	1,305	45.9	1,165	5	5	3,060	1,500	2,950	1,440	7,200	3,266
	TF430	170.7	4,335	77.6	1,970	38.3	972	55.3	1,405	49.8	1,265	5	5	2,990	1,475	2,880	1,420	7,242	3,285
	TF450	178.5	4,535	81.5	2,070	42.2	1,072	61.2	1,555	55.7	1,415	5	5	2,950	1,450	2,840	1,390	7,286	3,305
	TF470	186.4	4,735	83.5	2,120	44.2	1,122	61.2	1,555	55.7	1,415	5	5	2,910	1,425	2,800	1,370	7,308	3,315
	TF500	198.2	5,035	87.4	2,220	48.1	1,222	65.2	1,655	59.6	1,515	5	5	2,860	1,400	2,750	1,340	7,352	3,335
	TF550	217.9	5,535	95.3	2,420	56.0	1,422	75.0	1,905	69.5	1,765	5	5	2,750	1,325	2,600	1,300	7,440	3,375
	TF600	237.6	6,035	103.1	2,620	63.9	1,622	82.9	2,105	77.4	1,965	5	5	2,550	1,250	2,460	1,200	7,579	3,438
	TF650	257.3	6,535	111.0	2,820	71.7	1,822	90.0	2,285	84.4	2,145	3	3	2,160	1,050	2,070	1,000	7,679	3,483
	TF700	277.0	7,035	118.9	3,020	79.6	2,022	97.0	2,465	91.5	2,325	3	3	1,870	900	1,780	860	7,765	3,522
	TS430	170.7	4,335	77.6	1,970	38.3	972	51.5	1,307	44.8	1,137	5	5	2,990	1,475	2,880	1,420	7,242	3,285
	TS450	178.5	4,535	81.5	2,070	42.2	1,072	57.4	1,457	50.7	1,287	5	5	2,950	1,450	2,840	1,390	7,286	3,305
	TS470	186.4	4,735	83.5	2,120	44.2	1,122	57.4	1,457	50.7	1,287	5	5	2,910	1,425	2,800	1,370	7,308	3,315
	TS500	198.2	5,035	87.4	2,220	48.1	1,222	61.3	1,557	54.6	1,387	5	5	2,860	1,400	2,750	1,340	7,352	3,335
	TS550	217.9	5,535	95.3	2,420	56.0	1,422	71.1	1,807	64.4	1,637	5	5	2,750	1,325	2,600	1,300	7,440	3,375
	TS600	237.6	6,035	103.1	2,620	63.9	1,622	79.0	2,007	72.3	1,837	5	5	2,550	1,250	2,460	1,200	7,579	3,438
	TS650	257.3	6,535	111.0	2,820	71.7	1,822	86.1	2,187	79.4	2,017	3	3	2,160	1,050	2,070	1,000	7,679	3,483
TS700	277.0	7,035	118.9	3,020	79.6	2,022	93.2	2,367	86.5	2,197	3	3	1,870	900	1,780	860	7,765	3,522	

\* : Standard  
 ※TS-Mast : Wide Visible 3-Stage Full Free Lift Mast with 2 Free Lift Cylinders.



## 18B-9



Mast Type	Maximum Fork Height		Overall Height (Lowered)		Free lift height						Tilt Angle		Load capacity w/o side shift		Load capacity w/side shift		Truck Weight (Unloaded)		
	in	mm	in	mm	With Load Backrest		Without Load Backrest		Without Load Backrest (3/4-SPOOL)		Fwd deg	Bwd deg	24 in LC lb	500mm LC kg	24 in LC lb	500mm LC kg	lb	kg	
					in	mm	in	mm	in	mm									
2-STAGE LIMITED FREE LIFT	V250	99.4	2,525	68.1	1,729	1.4	35	1.4	35	1.4	35	5	7	3,500	1,800	3,500	1,730	7,105	3,223
	V270	107.3	2,725	72.0	1,829							5	7	3,500	1,800	3,500	1,730	7,132	3,235
	V300	119.1	3,025	77.9	1,979							5	7	3,500	1,800	3,500	1,730	7,176	3,255
	*V330	130.9	3,325	83.8	2,129							5	7	3,500	1,800	3,500	1,730	7,220	3,275
	V350	138.8	3,525	87.8	2,229							5	7	3,500	1,800	3,500	1,730	7,249	3,288
	V370	146.7	3,725	91.7	2,329							5	7	3,500	1,800	3,500	1,730	7,277	3,301
	V400	158.5	4,025	97.6	2,479							5	7	3,500	1,800	3,500	1,730	7,330	3,325
	V450	178.1	4,525	111.4	2,829							5	5	3,500	1,750	3,430	1,680	7,480	3,393
	V500	197.8	5,025	121.2	3,079							5	5	3,370	1,650	3,260	1,590	7,553	3,426
	V550	217.5	5,525	131.1	3,329							5	5	3,280	1,600	3,170	1,540	7,597	3,446
2-STAGE FULL FREE LIFT	VF/V300	119.1	3,025	77.9	1,979	38.6	981	58.2	1,479	52.7	1,339	5	5	3,500	1,800	3,500	1,730	7,260	3,293
	VF/V330	130.9	3,325	83.8	2,129	44.5	1,131	64.1	1,629	58.6	1,489	5	5	3,500	1,800	3,500	1,730	7,308	3,315
3-STAGE FULL FREE LIFT	VF350	138.8	3,525	87.8	2,229	48.5	1,231	68.1	1,729	62.6	1,589	5	5	3,500	1,800	3,500	1,730	7,341	3,330
	TF370	147.0	3,735	70.0	1,779	30.7	781	47.4	1,205	41.9	1,065	5	5	3,500	1,800	3,500	1,730	7,429	3,370
	TF400	158.9	4,035	74.0	1,879	34.7	881	51.4	1,305	45.9	1,165	5	5	3,500	1,750	3,430	1,690	7,474	3,390
	TF430	170.7	4,335	77.9	1,979	38.6	981	55.3	1,405	49.8	1,265	5	5	3,500	1,725	3,390	1,660	7,518	3,410
	TF450	178.5	4,535	81.9	2,079	42.6	1,081	61.2	1,555	55.7	1,415	5	5	3,460	1,700	3,350	1,640	7,560	3,429
	TF470	186.4	4,735	83.8	2,129	44.5	1,131	61.2	1,555	55.7	1,415	5	5	3,370	1,650	3,240	1,590	7,584	3,440
	TF500	198.2	5,035	87.8	2,229	48.5	1,231	65.2	1,655	59.6	1,515	5	5	3,260	1,600	3,150	1,540	7,628	3,460
	TF550	217.9	5,535	95.6	2,429	56.3	1,431	75.0	1,905	69.5	1,765	5	5	3,080	1,500	2,970	1,450	7,714	3,499
	TF600	237.6	6,035	103.5	2,629	64.2	1,631	82.9	2,105	77.4	1,965	5	5	2,770	1,350	2,690	1,300	7,855	3,563
	TF650	257.3	6,535	111.4	2,829	72.1	1,831	90.0	2,285	84.4	2,145	3	3	2,690	1,300	2,580	1,250	7,954	3,608
	TF700	277.0	7,035	119.3	3,029	80.0	2,031	98.4	2,499	92.9	2,359	3	3	2,180	1,050	2,090	1,010	8,038	3,646
	TS430	170.7	4,335	77.9	1,979	38.6	981	51.5	1,307	44.8	1,137	5	5	3,500	1,725	3,390	1,660	7,518	3,410
	TS450	178.5	4,535	81.9	2,079	42.6	1,081	57.4	1,457	50.7	1,287	5	5	3,460	1,700	3,350	1,640	7,560	3,429
	TS470	186.4	4,735	83.8	2,129	44.5	1,131	57.4	1,457	50.7	1,287	5	5	3,370	1,650	3,240	1,590	7,584	3,440
	TS500	198.2	5,035	87.8	2,229	48.5	1,231	61.3	1,557	54.6	1,387	5	5	3,260	1,600	3,150	1,540	7,628	3,460
	TS550	217.9	5,535	95.6	2,429	56.3	1,431	71.1	1,807	64.4	1,637	5	5	3,080	1,500	2,970	1,450	7,714	3,499
	TS600	237.6	6,035	103.5	2,629	64.2	1,631	79.0	2,007	72.3	1,837	5	5	2,770	1,350	2,690	1,300	7,855	3,563
	TS650	257.3	6,535	111.4	2,829	72.1	1,831	86.1	2,187	79.4	2,017	3	3	2,690	1,300	2,580	1,250	7,954	3,608
	TS700	277.0	7,035	119.3	3,029	80.0	2,031	93.2	2,367	86.5	2,197	3	3	2,180	1,050	2,090	1,010	8,038	3,646

\* : Standard  
 ※TS-Mast : Wide Visible 3-Stage Full Free Lift Mast with 2 Free Lift Cylinders.

## New 9 Series Mast Specifications

## 20B-9



Mast Type	Maximum Fork Height		Overall Height (Lowered)		Free lift height						Tilt Angle		Load capacity w/o side shift		Load capacity w/side shift		Truck Weight (Unloaded)		
	in	mm	in	mm	With Load Backrest		Without Load Backrest		Without Load Backrest (3/4-SPOOL)		Fwd deg	Bwd deg	24 in LC lb	500mm LC kg	24 in LC lb	500mm LC kg	lb	kg	
					in	mm	in	mm	in	mm									
2-STAGE LIMITED FREE LIFT	V250	99.6	2,530	68.1	1,729	1.6	40	1.6	40	1.6	40	5	7	4,000	2,000	3,900	1,930	7,557	3,428
	V270	107.5	2,730	72.0	1,829							5	7	4,000	2,000	3,900	1,930	7,584	3,440
	V300	119.3	3,030	77.9	1,979							5	7	4,000	2,000	3,900	1,930	7,628	3,460
	*V330	131.1	3,330	83.8	2,129							5	7	4,000	2,000	3,900	1,930	7,672	3,480
	V350	139.0	3,530	87.8	2,229							5	7	4,000	2,000	3,900	1,930	7,701	3,493
	V370	146.9	3,730	91.7	2,329							5	7	4,000	2,000	3,900	1,920	7,729	3,506
	V400	158.7	4,030	97.6	2,479							5	7	4,000	2,000	3,900	1,920	7,784	3,531
	V450	178.3	4,530	111.4	2,829							5	5	3,920	1,925	3,790	1,860	7,932	3,598
	V500	198.0	5,030	121.2	3,079							5	5	3,790	1,850	3,660	1,790	8,007	3,632
	V550	217.7	5,530	131.1	3,329							5	5	3,630	1,775	3,520	1,710	8,051	3,652
2-STAGE FULL FREE LIFT	VF/V300	119.3	3,030	77.9	1,979	38.8	986	58.4	1,484	50.4	1,280	5	5	4,000	2,000	3,900	1,930	7,714	3,499
	VF/V330	131.1	3,330	83.8	2,129	44.7	1,136	64.3	1,634	56.3	1,430	5	5	4,000	2,000	3,900	1,930	7,760	3,520
3-STAGE FULL FREE LIFT	VF350	139.0	3,530	87.8	2,229	48.7	1,236	68.3	1,734	60.2	1,530	5	5	4,000	2,000	3,900	1,930	7,793	3,535
	TF370	147.2	3,740	70.0	1,779	30.9	786	47.6	1,210	39.6	1,006	5	5	4,000	2,000	3,900	1,930	7,884	3,576
	TF400	159.1	4,040	74.0	1,879	34.9	886	51.6	1,310	43.5	1,106	5	5	3,960	1,950	3,830	1,880	7,928	3,596
	TF430	170.9	4,340	77.9	1,979	38.8	986	55.5	1,410	47.5	1,206	5	5	3,920	1,925	3,770	1,860	7,970	3,615
	TF450	178.7	4,540	81.9	2,079	42.8	1,086	61.4	1,560	55.4	1,406	5	5	3,880	1,900	3,720	1,840	8,014	3,635
	TF470	186.6	4,740	83.8	2,129	44.7	1,136	61.4	1,560	53.4	1,356	5	5	3,770	1,850	3,660	1,790	8,036	3,645
	TF500	198.4	5,040	87.8	2,229	48.7	1,236	65.4	1,660	57.3	1,456	5	5	3,700	1,800	3,570	1,750	8,080	3,665
	TF550	218.1	5,540	95.6	2,429	56.5	1,436	75.2	1,910	69.1	1,756	5	5	3,480	1,700	3,370	1,640	8,168	3,705
	TF600	237.8	6,040	103.5	2,629	64.4	1,636	83.1	2,110	77.0	1,956	5	5	3,350	1,600	3,170	1,540	8,307	3,768
	TF650	257.5	6,540	111.4	2,829	72.3	1,836	90.2	2,290	83.3	2,116	3	3	2,690	1,300	2,600	1,250	8,406	3,813
	TF700	277.2	7,040	119.3	3,029	80.2	2,036	98.6	2,504	92.3	2,344	3	3	2,400	1,150	2,310	1,100	8,492	3,852
	TS430	170.9	4,340	77.9	1,979	38.8	986	51.7	1,312	38.6	980	5	5	3,920	1,925	3,770	1,860	7,970	3,615
	TS450	178.7	4,540	81.9	2,079	42.8	1,086	57.6	1,462	46.5	1,180	5	5	3,880	1,900	3,720	1,840	8,014	3,635
	TS470	186.6	4,740	83.8	2,129	44.7	1,136	57.6	1,462	44.5	1,130	5	5	3,770	1,850	3,660	1,790	8,036	3,645
	TS500	198.4	5,040	87.8	2,229	48.7	1,236	61.5	1,562	48.4	1,230	5	5	3,700	1,800	3,570	1,750	8,080	3,665
	TS550	218.1	5,540	95.6	2,429	56.5	1,436	71.3	1,812	60.2	1,530	5	5	3,480	1,700	3,370	1,640	8,168	3,705
	TS600	237.8	6,040	103.5	2,629	64.4	1,636	79.2	2,012	68.1	1,730	5	5	3,350	1,600	3,170	1,540	8,307	3,768
	TS650	257.5	6,540	111.4	2,829	72.3	1,836	86.3	2,192	74.4	1,890	3	3	2,690	1,300	2,600	1,250	8,406	3,813
	TS700	277.2	7,040	119.3	3,029	80.2	2,036	93.4	2,372	80.7	2,050	3	3	2,400	1,150	2,310	1,100	8,492	3,852

\* : Standard  
 ※TS-Mast : Wide Visible 3-Stage Full Free Lift Mast with 2 Free Lift Cylinders.



# New 9 Series

16/18/20B-9

## Load Capacity

16B-9

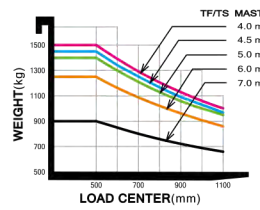
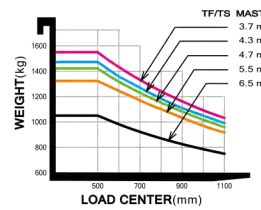
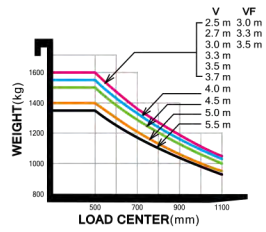

18B-9

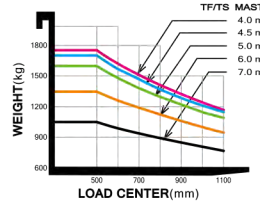
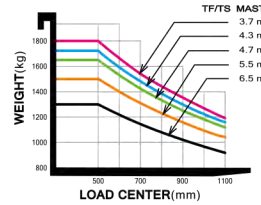
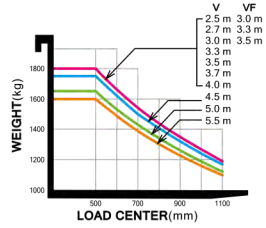

20B-9

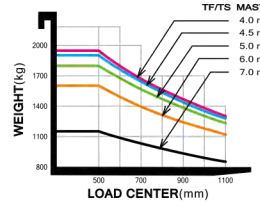
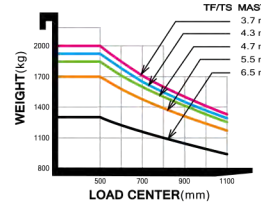
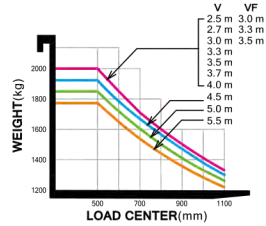

## Optional Items

- Fork (mm)  
16 / 18B-9 : 35X100X750, 850, 900(STD), 1050, 1200, 1350, 1500  
20B-9 : 40X100X900(STD), 950, 1000, 1050, 1150, 1200, 1350, 1500, 1600
- Integral Sideshift / Sideshift
- Tire : SOLID(STD) / Non-marking / Wide tire [16B-9 : Front tire (200 / 50-10)]
- Seat : Grammer
- M.C.V : 2-Spool (STD), 3-Spool, 4-Spool
- Auto Fork Leveling
- Beacon Lamp
- Load Indicator

- Work Lamp
- OPSS : Mast
- UL : ES, EE
- Direction Switch on Lever
- Cold Storage  
(for -30° c cold working environments)
- Cabin  
① : Front + Roof / ② : ① + Rear /  
③ : ② + Side door / ④ : ③ + Heater /  
⑤ : ④ + Audio

## Various Attachments

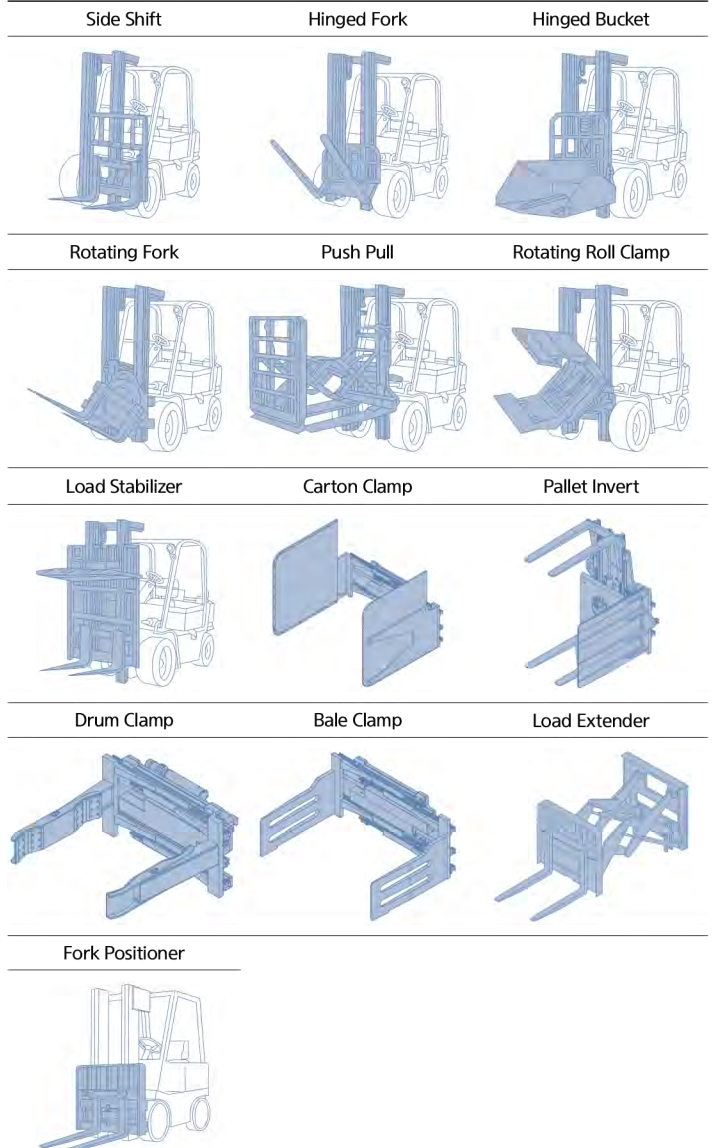

\* Exterior designs and forklift options in this catalog may change for improvement

## New 9 Series

## Specification

Identification		Hyundai			
1.1	Manufacturer	Hyundai			
1.2	Model	16B-9	18B-9	20B-9	
1.3	Power type / Electric	Electric	Electric	Electric	
1.4	Operator type / Driver-seated	Driver-seated	Driver-seated	Driver-seated	
1.5	Load capacity	Q kg	1,600	1,800	2,000
1.6	Load center distance	c mm	500	500	500
1.8	Forward overhang (LMC)	x mm	360	360	365
1.9	Wheel base distance	y mm	1,355	1,440	1,440
Weights					
2.1	Truck weight	kg	3,150	3,275	3,480
2.2	Axle load (w/ front, rear load)	kg	4,200 / 550	4,478 / 597	4,850 / 630
2.3	Axle load (w/o front, rear load)	kg	1,585 / 1,565	1,603 / 1,672	1,650 / 1,830
Tires					
3.1	Tire type: solid (V), pneumatic (P), polyurethane (PE)		SE	SE	SE
3.2	Front Tire size (Φ x width)		18x7-8	200 / 50-10	200 / 50-10
3.3	Rear tire size (Φ x width)		16x6-8	16x6-8	16x6-8
3.5	Wheels, number front rear(x = driven wheels)		2x / 2	2x / 2	2x / 2
3.6	Track width (front)	mm	895	905	905
3.7	Track width (rear)	mm	880	880	880
Dimensions					
4.1	Mast / fork carriage tilt forward / backward	degrees	5 / 7	5 / 7	5 / 7
4.2	Lowered mast height	h1 mm	2,120	2,129	2,129
4.3	Free lift height	h2 mm	35	35	40
4.4	Lift height	h3 mm	3,325	3,325	3,330
4.5	Extended mast height	h4 mm	4,320	4,320	4,320
4.7	Overhead guard (cab) height	h5 mm	2,065	2,065	2,065
4.8	Seat height / Standing height	h7 mm	1,090	1,090	1,090
4.12	Coupling height	h10 mm	250	250	250
4.19	Overall length	l1 mm	2,935	3,020	3,030
4.20	Length to face of forks	l2 mm	2,035	2,120	2,130
4.21	Overall width	b1 mm	1,074	1,105	1,105
4.22	Fork dimension (length x width x thickness)	s / e / l	35x100x900	35x100x900	40x100x900
4.23	Fork carriage ISO 2328, class / type A, B	mm	II/A	II/A	II/A
4.24	Fork - carriage width	b3 mm	1,006	1,006	1,006
4.31	Minimum ground clearance (mast)	m1 mm	85	94	94
4.32	Minimum ground clearance (center of wheelbase)	m2 mm	90	90	100
4.33	Intersecting aisle width (pallets 1,000 x 1,200)	Ast mm	3,352	3,427	3,447
4.35	Minimum turning radius	Wa mm	1,710	1,795	1,810

Performance Data					
5.1	Travel speed, loaded / unloaded	km/h	16 / 17	16 / 17	16 / 17
5.2	Lift speed, loaded / unloaded	mm/s	410 / 600	410 / 600	410 / 600
5.3	Lowering speed, loaded / unloaded	mm/s	500 / 450	500 / 450	500 / 450
5.6	Loaded/unloaded maximum drawbar pull	N	15,102 / 14,759	15,190 / 14,710	14,367 / 14,043
5.8	Loaded/unloaded gradeability	% (°)	29.5 (16.4)	27.5 (15.4)	24.5 (13.8)
5.10	Service brake		hydraulic	hydraulic	hydraulic
E - Motor					
6.1	Drive motor rating S2 60 min	kW	4.7x2	4.7x2	4.7x2
6.2	Pump motor rating at S3 - 15 %	kW	14.0	14.0	14.0
6.4	Battery voltage, nominal capacity K5	V/Ah	48 / 510	48 / 585	48 / 585
6.5	Battery weight	kg	850	1,030	1,030
	Battery dimensions (L / W / H)	mm	978 / 545 / 635	978 / 630 / 635	978 / 630 / 635
Other Details					
8.1	Type of drive control		AC	AC	AC

## Dimension

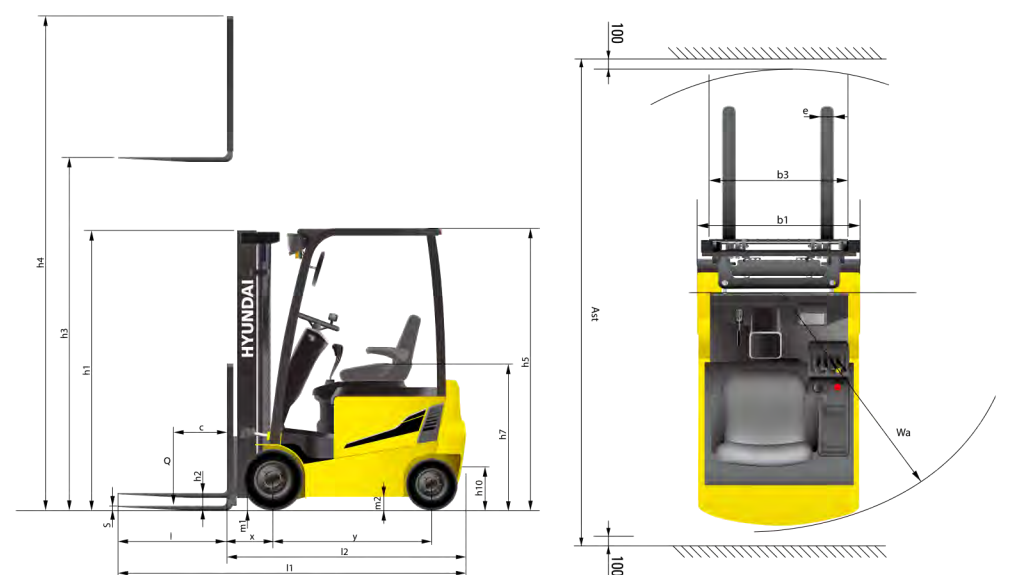

\* Exterior designs and forklift options in this catalog may change for improvement